



## SHANK GUIDE

Shank Icon **FG**  **RA** 

Shank **SS**  **FG**  **RA** 

OAL (Over All Length) Friction Grip Shank 19.0 mm to 28.0 mm Right Angle Shank 19.0 mm to 26.0 mm

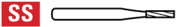
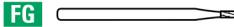
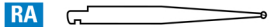
Short Shank 16.1 mm to 16.5 mm Friction Grip Surgical Length Shank 23.0 to 28.0 mm Right Angle Surgical Length Shank 25.0 mm

HP (One / Straight Hand-piece) Shank 44.5 mm

## SPECIFICATIONS

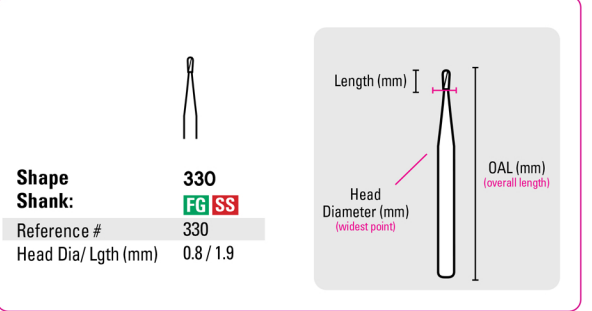

Individually wrapped and highly visible through a poly packet, each diamond is identified by bur number and shape description.

Single-use [nbifu.com](http://nbifu.com)

## OPERATIVE

OAL 19.0mm

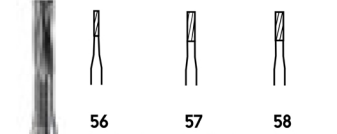
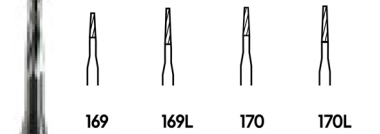
Round	Inverted Cone	Straight Fissure	Tapered Fissure	Amalgam Prep	Pear	Straight Fissure Crosscut	Tapered Fissure Crosscut
<p><b>50</b></p> <p><b>10</b> *10pk only available on selected shapes</p>  <p>Shape: 1/4, 1/2, 1, 2, 4, 6, 8            Shank: FG RA, FG RA, FG RA, FG RA SS, FG RA SS, FG RA, FG RA            Reference #: 1/4, 1/2, 1, 2, 4, 6, 8            Head Dia/Lgth (mm): 0.5/0.5, 0.6/0.5, 0.8/0.7, 1.0/0.9, 1.4/1.3, 1.8/1.6, 2.3/2.1</p>	 <p>Shape: 33 1/2, 34, 35, 36, 37            Shank: FG, FG RA, FG RA SS, FG, FG            Reference #: 33 1/2, 34, 35, 36, 37            Head Dia/Lgth (mm): 0.6/0.5, 0.8/0.7, 1.0/0.8, 1.2/1.0, 1.4/1.2</p>	 <p>Shape: 56, 57, 58            Shank: FG SS, FG SS, FG            Reference #: 56, 57, 58            Head Dia/Lgth (mm): 0.8/3.3, 1.0/3.9, 1.2/3.9</p>	 <p>Shape: 169, 169L, 170, 170L            Shank: FG, FG, FG, FG            Reference #: 169, 169L, 170, 170L            Head Dia/Lgth (mm): 0.9/3.5, 0.9/4.9, 1.0/3.9, 1.0/4.9</p>	 <p>Shape: 245            Shank: FG SS            Reference #: 245            Head Dia/Lgth (mm): 0.9/2.8</p>	 <p>Shape: 329, 330, 331, 331L, 332            Shank: FG, FG SS, FG SS, FG SS, FG            Reference #: 329, 330, 331, 331L, 332            Head Dia/Lgth (mm): 0.6/1.0, 0.8/2.0, 1.0/1.8, 1.0/3.7, 1.2/2.0</p>	 <p>Shape: 556, 557, 557L, 558            Shank: FG SS, FG SS, FG, FG            Reference #: 556, 557, 557L, 558            Head Dia/Lgth (mm): 0.8/3.3, 1.0/3.9, 1.0/4.9, 1.2/3.9</p>	 <p>Shape: 699, 700, 701, 701L, 702            Shank: FG, FG, FG, FG, FG            Reference #: 699, 700, 701, 701L, 702            Head Dia/Lgth (mm): 0.9/3.5, 1.0/3.9, 1.2/3.9, 1.2/4.9, 1.6/4.4</p>

## ESTHETIC FINISHERS

OAL 19.0 to 23.0mm

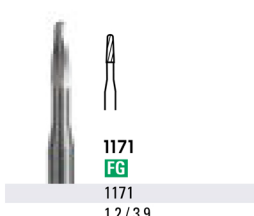
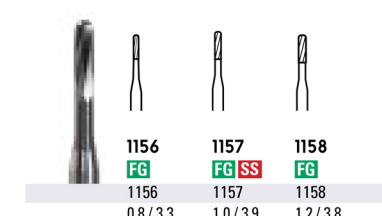
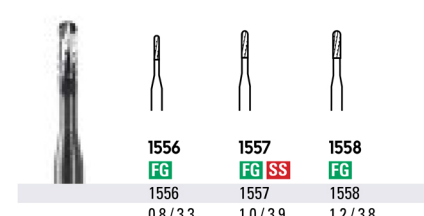
Round End Tapered Fissure	Round End Fissure	Round End Fissure Crosscut
 <p>Shape: 1171            Shank: FG            Reference #: 1171            Head Dia/Lgth (mm): 1.2/3.9</p>	 <p>Shape: 1156, 1157, 1158            Shank: FG, FG SS, FG            Reference #: 1156, 1157, 1158            Head Dia/Lgth (mm): 0.8/3.3, 1.0/3.9, 1.2/3.8</p>	 <p>Shape: 1556, 1557, 1558            Shank: FG, FG SS, FG            Reference #: 1556, 1557, 1558            Head Dia/Lgth (mm): 0.8/3.3, 1.0/3.9, 1.2/3.8</p>



## SURGICAL LENGTH

OAL 23.0 to 28.0mm

Round
<p><b>25</b></p> <p><b>10</b> *10pk only available on selected shapes</p>  <p>Shape: SL 1/2, SL1, SL2, SL4, SL6, SL8            Shank: FG, FG, FG RA, FG RA, FG RA, FG RA            Reference #: SL 1/2, SL1, SL2, SL4, SL6, SL8            Head Dia/Lgth (mm): 0.6/0.5, 0.8/0.7, 1.0/0.9, 1.4/1.3, 1.8/1.6, 2.3/2.1</p>

## METAL CUTTERS

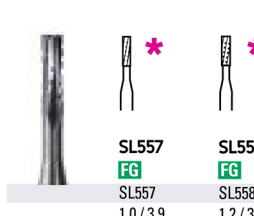
OAL 19.0mm

Round	Straight Fissure Crosscut	Tapered Fissure Crosscut
 <p>Shape: SL557, SL558            Shank: FG, FG            Reference #: SL557, SL558            Head Dia/Lgth (mm): 1.0/3.9, 1.2/3.9</p>	 <p>Shape: SL701, SL702            Shank: FG, FG            Reference #: SL701, SL702            Head Dia/Lgth (mm): 1.2/3.9, 1.6/4.4</p>	



## NEOMAX® Metal Cutters

OAL 19.0 to 20.3mm

Round End Taper	Flat End Taper	Football (Egg)
 <p>Shape: MAX 1, MAX 2            Shank: FG, FG            Reference #: GW1/1931, GW2/1958            Head Dia/Lgth (mm): 1.0/2.0, 1.2/4.1</p>	 <p>Shape: CK85616, CK85618            Shank: FG, FG            Reference #: 856-016, 856-018            Head Dia/Lgth (mm): 1.6/7.9/1.2, 1.8/8.0/1.5, 20.3, 20.3</p>	 <p>Shape: CK84716, CK37923            Shank: FG, FG            Reference #: 847-016, 379-023            Head Dia/Lgth (mm): 1.6/8.0/1.2, 2.3/4.3, 20.3, 19.0</p>

## 30-BLADE TRIMMING & FINISHING

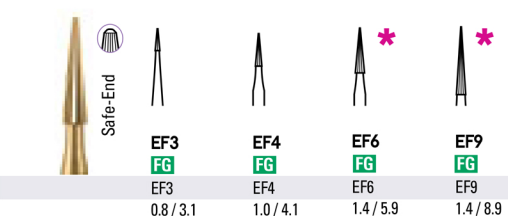
OAL 19.0 to 23.0mm

EF-Series 10 Straight-Blades	Egg 12 Spiral-Blades	Bullet 12 Straight-Blades
<p><b>25</b></p> <p><b>10</b> *10pk only available on selected shapes</p>  <p>Shape: EF3, EF4, EF6, EF9            Shank: FG, FG, FG, FG            Reference #: EF3, EF4, EF6, EF9            Head Dia/Lgth (mm): 0.8/3.1, 1.0/4.1, 1.4/5.9, 1.4/8.9, 23.0, 20.5, 21.0, 24.0</p>	 <p>Shape: OS1            Shank: FG            Reference #: (7379)            Head Dia/Lgth (mm): 2.3/4.3, 19.0</p>	 <p>Shape: OS2, OS3            Shank: FG, FG            Reference #: (7801), OS3            Head Dia/Lgth (mm): 0.9/3.2, 0.7/3.3, 20.5, 20.5</p>



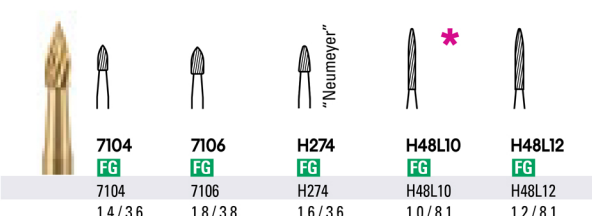
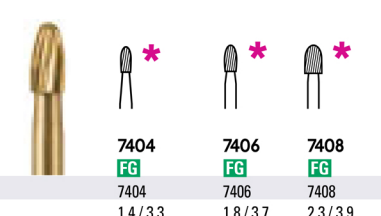

## 12-BLADE TRIMMING & FINISHING

OAL 19.0 to 23.0mm

Round	Flame	Egg
 <p>Shape: 7006            Shank: FG            Reference #: 7006            Head Dia/Lgth (mm): 1.8/1.6, 19.0</p>	 <p>Shape: 7104, 7106, H274, H48L10, H48L12            Shank: FG, FG, FG, FG, FG            Reference #: 7104, 7106, H274, H48L10, H48L12            Head Dia/Lgth (mm): 1.4/3.6, 1.8/3.8, 1.6/3.6, 1.0/8.1, 1.2/8.1, 19.0, 22.0, 22.0</p>	 <p>Shape: 7404, 7406, 7408            Shank: FG, FG, FG            Reference #: 7404, 7406, 7408            Head Dia/Lgth (mm): 1.4/3.3, 1.8/3.7, 2.3/3.9, 19.0, 19.0, 19.0</p>

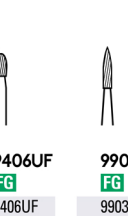

## ESTHETIC FINISHERS

OAL 19.0 to 23.0mm

Esthetic Finisher	Inter proximal	Pointed Taper	Egg	Needle
 <p>Shape: EF9UF            Shank: FG            Reference #: EF9UF            Head Dia/Lgth (mm): 1.4/8.9, 24.0</p>	 <p>Shape: 9103UF            Shank: FG            Reference #: 9103UF            Head Dia/Lgth (mm): 1.2/3.6, 19.0</p>	 <p>Shape: 9214UF            Shank: FG            Reference #: 9214UF            Head Dia/Lgth (mm): 1.0/5.6, 22.0</p>	 <p>Shape: 9406UF            Shank: FG            Reference #: 9406UF            Head Dia/Lgth (mm): 1.8/3.7, 19.0</p>	 <p>Shape: 9903UF            Shank: FG            Reference #: 9903UF            Head Dia/Lgth (mm): 1.2/5.5, 21.0</p>

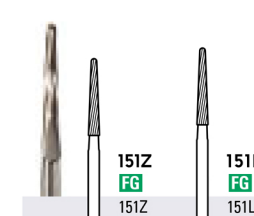
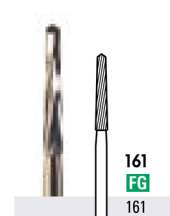

## SURGICAL

OAL 23.0 to 28.0mm

151Z	Lindemann Straight	ENDO ACCESS
 <p>Shape: 151Z, 151LZ            Shank: FG, FG            Reference #: 151Z, 151LZ            Head Dia/Lgth (mm): 1.6/11.0, 1.6/11.0, 23.0, 28.0</p>	 <p>Shape: 161, 162            Shank: FG, FG            Reference #: 161, 162            Head Dia/Lgth (mm): 1.6/10.0, 1.6/10.0, 25.0, 25.0</p>	 <p>Shape: 152            Shank: FG            Reference #: 152            Head Dia/Lgth (mm): 1.6/9.1, 23.0</p>

## ENDO ACCESS

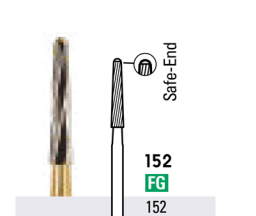
OAL 23.0mm

Endo Access	HP ORAL SURGERY
 <p>Shape: 152            Shank: FG            Reference #: 152            Head Dia/Lgth (mm): 1.6/9.1, 23.0</p>	 <p>Shape: HP 2, HP 4, HP 6, HP 8            Shank: FG, FG, FG, FG            Reference #: HP 2, HP 4, HP 6, HP 8            Head Dia/Lgth (mm): 1.0/0.9, 1.4/1.3, 1.8/1.6, 2.3/2.1, 44.5, 44.5, 44.5, 44.5</p>

## HP ORAL SURGERY

OAL 44.5mm

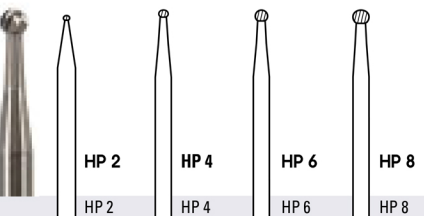
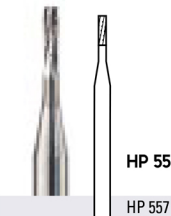
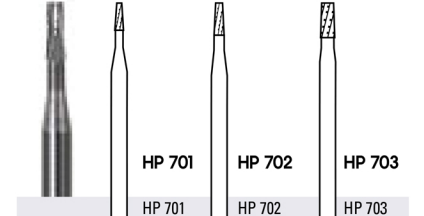
Round	Straight Fissure Crosscut	Tapered Fissure Crosscut
 <p>Shape: HP 2, HP 4, HP 6, HP 8            Shank: FG, FG, FG, FG            Reference #: HP 2, HP 4, HP 6, HP 8            Head Dia/Lgth (mm): 1.0/0.9, 1.4/1.3, 1.8/1.6, 2.3/2.1, 44.5, 44.5, 44.5, 44.5</p>	 <p>Shape: HP 557            Shank: FG            Reference #: HP 557            Head Dia/Lgth (mm): 1.0/3.9, 44.5</p>	 <p>Shape: HP 701, HP 702, HP 703            Shank: FG, FG, FG            Reference #: HP 701, HP 702, HP 703            Head Dia/Lgth (mm): 1.2/3.9, 1.6/4.4, 2.1/4.9, 44.5, 44.5, 44.5</p>

## ROUND FISSURE CROSSCUT

OAL 44.5mm

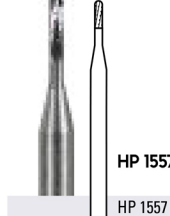
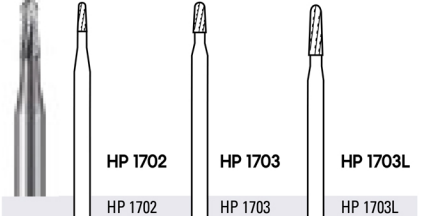
Round Fissure Crosscut	Round Tapered Fissure Crosscut
 <p>Shape: HP 1557            Shank: FG            Reference #: HP 1557            Head Dia/Lgth (mm): 1.0/3.9, 44.5</p>	 <p>Shape: HP 1702, HP 1703, HP 1703L            Shank: FG, FG, FG            Reference #: HP 1702, HP 1703, HP 1703L            Head Dia/Lgth (mm): 1.6/4.4, 2.1/4.9, 2.1/6.9, 44.5, 44.5, 44.5</p>